

18	RESIDENTIAL ZONE RULES
-----------	-------------------------------

Activities Tables

Policies 4.4.3, 4.4.11, 4.4.13, 9.4.4, 9.4.5, 9.4.10, 16.4.3, 16.4.7

18.1 Subdivision Activities	
Subdivision excluding unit title subdivision	
Subdivision which complies with the standards in rules 18.5 and 18.9 unless specified below	C
Subdivision in the Wallaceville Structure Plan Area (Chapter 39: Wallaceville) which complies with the standards in rules 18.5 and 18.9 unless specified below	RD
Subdivision in the Wallaceville Structure Plan Area that does not comply with the standards of rule 18.5 and 18.9	D
Subdivision which does not comply with the standards specified in rule 18.5	D
Subdivision which complies with the standards of rule 18.5 but not rule 18.9	RD
Subdivision around any existing lawfully established dwelling which does not result in the creation of any new undeveloped site that contains no dwelling Note: this form of subdivision does not need to comply with the minimum net site area requirements of rule 18.5, but does need to meet the access standards of rule 18.9	C
Subdivision around any existing lawfully established dwelling that does not result in the creation of any new undeveloped site that contains no dwelling, that does not comply with the access standards of rule 18.9	RD
Subdivision of land for utilities, reserves or conservation purposes	C
Subdivision of a site identified in Schedules 26.8 or 27.7	D
Creation of a lot that does not have formed legal access to a formed legal road, unless the proposal is for a paper road or other access to be formed as a condition of subdivision approval in accordance with the Code of Practice for Civil Engineering Works	NC
Subdivision which creates building platforms within 20m of high voltage (110kV or greater) electricity transmission lines as shown on the Planning Maps *(refer to the definition of <i>transmission line</i>)	RD
Subdivision within the Residential (Centres Overlay) Area which complies with the standards of rule 18.5 but not rule 18.9	RD
Subdivision within the Residential (Centres Overlay) Area which does not comply with the standards specified in rule 18.5	D
Subdivision within the Pinehaven Flood Hazard Extent and Pinehaven Catchment Overlay	
<u>Subdivision within the ponding area of the Pinehaven Flood Hazard Extent, which creates any undeveloped lots that do not contain a dwelling, and complies with the requirements of Rule 18.5.</u>	RD

Subdivision of a site within the Pinehaven Catchment Overlay	RD
Subdivision within the Pinehaven Flood Hazard Extent which creates any undeveloped lots that do not contain a dwelling, and does not: <ul style="list-style-type: none"> comply with the requirements of Rules 18.5, or; meet the standard of the Rule 18.37 	NC
Subdivision of a site within the Pinehaven Catchment Overlay that does not meet the standards for either Rule 18.38 or Rule 18.5	NC
Subdivision within the Mangaroa Flood Hazard Extent	
Subdivision within the Ponding Area or Erosion Hazard Area of the Mangaroa Flood Hazard Extent, which results in any undeveloped lots that contain no dwelling or non-residential building, and complies with the requirements of Rule 18.5.	RD
Subdivision within the Mangaroa Flood Hazard Extent which results in any new undeveloped lots that contain no dwelling, where the activity does not comply with the requirements of Rule 18.5; or the proposed building platform is located within a river corridor.	NC
Subdivision of Comprehensive Residential Developments	
Subdivision of a Comprehensive Residential Development applied for concurrently with a Comprehensive Residential Development under Rule 18.28A.	RD

Updates of existing company lease and cross lease, and all unit title subdivision	
Subdivision which is a unit title subdivision or an alteration to a company lease, unit title or cross lease title to include a building extension or alteration or accessory building on the site (excluding an additional dwelling) that has been lawfully established in terms of the Building Act 2004	C
In relation to land identified in Appendix Residential 3 ('Maidstone Terrace Residential')	
Subdivision which complies with standards in 18.5, 18.8A and 18.9	RD
Subdivision which does not comply with standards in 18.5, 18.8A and/or 18.9	NC
Any subdivision not provided for in this table	D

Key	P	Permitted activity which complies with standards for permitted activities specified in the Plan
	C	Controlled activity which complies with standards for controlled activities specified in the Plan
	RD	Restricted discretionary activity
	D	Discretionary activity
	NC	Non complying activity

18.2 Land Use Activities	
Residential Activities	
One dwelling per site	P
One family flat in conjunction with a dwelling on any site	P
Two or more dwellings on a site complying with the net site area standard of rule 18.10	C
Two or more dwellings on a site within a Residential (Centres Overlay) Area except on land identified as Pt Section 618 Hutt District complying with the net site area standard of rule 18.5	C
Two or more dwellings on a site within a Residential (Centres Overlay) Area that does not comply with the net site area standard of rule 18.5	D
Comprehensive Residential Development on a site within a Residential Centres Overlay) Area complying with the standards and terms of rule 18.28A	RD
Comprehensive Residential Development on a site within a Residential Centres Overlay) Area not complying with the standards and terms of rule 18.28A	D
Rest homes and community care housing	P
A family flat in conjunction with a dwelling where the family flat does not comply with permitted activity standards	RD
Removal of a building from a site	P
Establishment of a relocated building from another site	C
Buildings accessory to a permitted or controlled activity which do not comply with permitted and controlled activity standards	RD

In relation to the land identified in Appendix Residential 3 ('Maidstone Terrace Residential')	
Activities which do not comply with standards of 18.5, 18.8A, 18.9, 18.12 and/or 18.21(b)	NC
Rest homes and community care housing	NC
Non-Residential Activities	
Home occupations ancillary to residential activities carried out on the site	P
Home occupations ancillary to residential activities carried out on the site, which do not comply with permitted activity standards	RD
Work affecting indigenous or exotic trees in the Residential Conservation and Residential Hill Sub-zones	P
Work affecting indigenous or exotic trees in the Residential Conservation and Residential Hill Sub-zones which does not comply with the permitted activity standards	D
Veterinarian, medical and health clinics	D
Early childhood centre(s)	RD
Marae	C
Places of assembly (including places of worship, educational facilities)	D
Visitor accommodation including hotels and motels	D
Passive Recreation	P
Buildings accessory to a permitted or controlled activity which do not comply with permitted or controlled activity standards	RD
Signs	P
Signs which do not comply with permitted activity standards	RD
Gang fortifications	Prohibited
Buildings or structures within 12m of high voltage (110kV or greater) electricity transmission lines as shown on the Planning Maps *(refer to the definition of transmission line)	NC
Buildings or structures within 12-20m of high voltage (110kV or greater) electricity transmission lines as shown on the Planning Maps *(refer to the definition of transmission line)	RD
Activities listed as permitted or controlled which do not comply with the relevant standards in this chapter, except as specified below	D
Activities listed as permitted or controlled which do not comply with the access standards in 18.9	RD
Activities which are not listed in this Table unless otherwise covered in the City-wide provisions of the Plan	D

18.3**City-wide provisions**

Each activity including subdivision in the Residential Zone shall comply with the relevant permitted activity standards in the City-wide provisions of the Plan as listed below.

Chapter	City-wide provisions
23	Earthworks
24	Esplanade Reserves and Strips
25	Reserves and Leisure Facilities Contributions
25A	Temporary Events
26	Heritage Features
27	Notable Trees
27A	Urban Tree Groups and Removal of Indigenous Vegetation
28	Southern Hills Overlay Area and Protected Ridgelines
29	Water Bodies
30	Network Utilities
30A	Renewable Energy Generation
31	Car Parking
32	Noise and Vibration
33	Flooding and Fault Band Hazards
34	Hazardous Substances and Contaminated Land

18.4 Controlled activities – restrictions on notification

Subject to sections 95A(2)(b), 95A(2)(c), 95A(4) and 95C of the Act, a resource consent application for a controlled activity is precluded from public notification under section 95A and, subject to section 95B(3), is precluded from limited notification under section 95B(2) of the Act.

Standards for Permitted and Controlled Activities

18.5 Minimum requirements for subdivision

Policies 4.4.1, 4.4.9, 4.4.13

	Front lots	Rear lots	Corner lots	Land Identified in Appendix Residential 1
Residential Areas				
Minimum net site area	400m ² -	400m ² -	450m ² -	600m ² (900m ² average)
Minimum frontage	6m	N/A	6m	N/A
Shape factor	12m	12m	12m	12m
Residential (Centres Overlay) Areas				
Minimum net site area	300m ²	300m ²	350m ²	N/A
Minimum net site area for Comprehensive Residential Developments	No minimum	No minimum	No minimum	N/A
Minimum frontage	6m	N/A	6m	N/A
Shape factor	10m	10m	10m	N/A
Conservation and Hill Areas				
Minimum net site area	750m ² -	900m ² -	750m ² -	900m ² (1500m ² average)
Minimum frontage	6m	N/A	6m	N/A
Shape factor	17m	17m	17m	17m
Exemptions				
These standards shall not apply to any lot for utility, reserve or conservation purposes.				

18.6

Subdivision which complies with the standards in rule 18.5 and 18.9, and on land identified in Appendix Residential 3 which also complies with standard 18.8A, and subdivision of land for utilities, reserves or conservation purposes

Policies 4.4.2, 4.4.2A, 4.4.7, 4.4.12, 9.4.3, 10.4.1, 16.4.3

Excluding land identified in Appendix Residential 3 Council may impose conditions over the following matters:

- Design, appearance and layout of the subdivision.
- Landscaping.
- Provision of and effects on network utilities and/or services.
- Standard, construction and layout of vehicular access.
- Earthworks.
- Provision of esplanade reserves and strips.
- Protection of any special amenity feature.
- Financial contributions.
- The outcome of consultation with the owner or operator of regionally significant network utilities (excluding the National Grid) located on or in proximity to the site.
Note: Rule 18.29 covers subdivision within the Electricity Transmission Corridor.
- The outcome of consultation with the owner or operator of consented or existing renewable energy generation activities located on or in proximity to the site.

In relation to the land identified in Appendix Residential 1 Council may impose conditions over the following matters:

- Landscape character and visual amenity.

In relation to the land identified in appendix Residential 3, Council will restrict its discretion to the matters listed above, except that matter relating to Appendix Residential 1, and to:

- The measures necessary to address the interface of any residential development with both Maidstone Park and the Business Industrial Zone. These may include, but are not limited to:
 - the future orientation of dwellings and the location of habitable rooms, relative to the Mainstone Park and adjacent Business Industrial zoned properties;
 - the future orientation of buildings, fences or landscaping to buffer outdoor living spaces from adjacent Business Industrial zoned properties;
 - whether the subdivision could result in more than 12 dwellings being constructed within Area B in Appedix Residential 3; and
 - the imposition of the consent notices to give effect to these matters.

18.7 Subdivision which is a company lease, cross lease or unit title subdivision

Policy 10.4.1

In addition to the matters listed in rule 18.6, Council may impose conditions over the following matters:

- Allocation of accessory units to principal units and covenant areas to leased areas to ensure compliance with car park provisions and to ensure practical physical access to units.
- Allocation of areas.

18.8 More than one dwelling on a site

Policies 4.4.1, 4.4.2, 4.4.2A, 4.4.4, 4.4.12, 9.4.3 10.4.1

Council may impose conditions over the following matters:

- Design, appearance and layout of the development.
- Landscaping.
- Provision of and effects on utilities and/or services.
- Standard, construction and layout of vehicular access.
- Earthworks.
- Provision of esplanade reserves and strips.
- Protection of any special amenity feature.
- Financial contributions.

In relation to the land identified in Appendix Residential 3, Council may impose conditions over the following matters.

- The measures necessary to address the interface of any residential development with both Maidstone Park and the Business Industrial Zone. These may include, but are not limited to:
 - the orientation of dwellings and the location of habitable rooms relative to Maidstone Park and adjacent Business Industrial zoned properties;
 - the orientation of dwellings and the location of habitable rooms relative to Maidstone Park and adjacent Business Industrial zoned properties;
 - the orientation of buildings, fences or landscaping to buffer outdoor living spaces from adjacent Business Industrial zoned properties;
 - the orientation of buildings, fences or landscaping to buffer outdoor living spaces from adjacent Business Industrial zoned properties.

18.8A

Maximum number of lots and dwellings along Maidstone Terrace

Policies 4.4.2,
4.4.2A

In relation to the land identified as Area B in Appendix Residential 3,

- (a) There shall be no more than 12 dwellings. To avoid any doubt:
 - o The maximum is not the maximum number of dwellings on any particular site.
- (b) There shall be no more than 12 allotments.

18.9

Access standards for subdivision and land use activities

Policies 4.4.2,
4.4.2A, 4.4.7,
4.4.12, 9.4.3

- Where vehicle access points are shared by three or more dwelling units, for all rear lots and for all sites fronting arterial, or distributor/collector streets (identified in Chapter 37) there must be provision for turning a vehicle on site in order that vehicles do not reverse into the street.
- All accessways and manoeuvring areas shall be formed and surfaced in accordance with the Code of Practice for Civil Engineering Works. The required surfacing must be completed prior to certification of the survey plan. Exemption – the requirement for accessways serving sites solely occupied by unstaffed utilities shall be that the accessway shall be surfaced with permanent all weather surfacing for a minimum length of 5m from the edge of the road carriageway seal.
- All sites shall have practical vehicle access to car parking and loading spaces, in accordance with the Code of Practice for Civil Engineering Works. This requirement does not apply to sites solely occupied by unstaffed utilities, provided that vehicles associated with utilities shall not obstruct the footpath or create a traffic hazard on the road.
- Vehicular access to a corner lot shall be located no closer than 8m from the street corner. Where a site is located on an intersection of a primary or secondary arterial traffic route (identified in Chapter 37) the siting of the vehicular access shall be located as far as practicable from the corner of the street. The 8 metre setback shall be measured from where the two front boundaries of the site (refer to the definition of a corner lot) join, or in accordance with the diagram below.

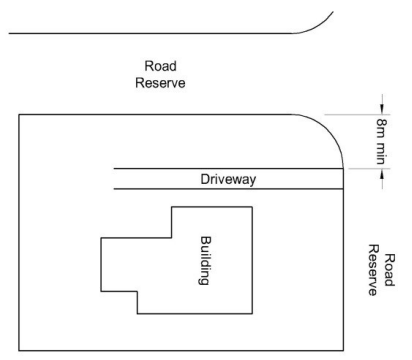

- Where a corner lot is located at an intersection of a national, primary or secondary arterial traffic route, as identified in Chapter 37, no building, fence or other structure is to be erected and no vegetation allowed to grow so as to obstruct a traffic sight line.
- At the intersection of a road or rail level crossing, no building, fence or other obstructions which block sight lines for trains shall be erected, placed or grown in the hatched area marked in Diagram A in Chapter 38.
- Subdivision and land use activities with direct access to a State Highway shall comply with the access and visibility standards set out in Diagrams B to E in Chapter 38.
- There shall be no private vehicle access to or egress from Alexander Road for any site contained within Area B of the Wallaceville Structure Plan Area.
- There shall be no new private vehicle access to or egress from Alexander Road to land identified as Lot 2 DP 471766, Pt Section 102B Hutt District Wellington or Pt Section 618 Hutt District.
- In relation to the land identified in Appendix Residential 3:
 - There will be no access off Maidstone Terrace. Access to the land shall be off Railway Avenue.
 - Neither a right of way, private way or legal boundary of any road or accessway serving the land shall at any point encroach within Area B of Appendix Residential 3.

18.10 Minimum net site area for dwellings

Policies 4.4.1, 4.4.2

The minimum net site area required for any dwelling to be erected on a site is the same as the minimum required for subdivision.

Exemption:

Within a Residential (Centres Overlay) Area there is no minimum net site area requirement for a dwelling forming a part of a Comprehensive Residential Development.

18.11 Site coverage

Policies 4.4.1, 4.4.2, 4.4.13

The maximum coverage by buildings on the net area of a site shall not exceed:

- 30% in the Residential Conservation and Residential Hill Sub-zones;
- 35% in the remainder of the Residential Zone; and
- 45% for Comprehensive Residential Development in the Residential (Centres Overlay) Areas.

Exemption:

Non-enclosed and uncovered decks.

18.12**Setbacks from boundaries**

Policies 4.4.2,
4.4.2A, 4.4.4

The setback distance for residential and non-residential buildings (excluding accessory buildings) shall not be less than:

Boundary	Minimum setback
In relation to the land identified in Area B of Appendix Residential 3, measured from the legal edge of Maidstone Terrace.	8m
Front boundary along all roads specifically named in Chapter 37 and all roads abutting the Residential Conservation and Residential Hill Sub-zones.	6m
Front boundary along all roads specifically named in Chapter 37 where the site is located within a Residential (Centres Overlay) Area.	4m
Front boundary along all other roads.	4m
Rear boundaries.	3m
Side boundaries except within the Residential Conservation and Residential Hill Sub-zones.	One of 1.5m & one of 3m
Side boundaries within the Residential Conservation and Residential Hill Sub-zones.	3m (both sides)
For Comprehensive Residential Development within the Urban Precinct of the Wallaceville Structure Plan Area: 1.5m	1.5m
Within the Wallaceville Structure Plan Area, rear and side boundaries adjoining rail corridor designation TZR1	5m

Notes:
<ul style="list-style-type: none"> On a rear lot, as defined in Chapter 2, rear boundary setbacks apply to all boundaries.
Exemptions:
<ul style="list-style-type: none"> Eaves, bay windows or similar features may encroach into boundary setbacks by up to 0.7m. Non-enclosed and uncovered decks of 1.0m or less in height above ground level.

18.13 Outdoor living court

Policy 4.4.2,
4.4.13

One outdoor living court capable of containing a 6m diameter circle shall be provided for each dwelling and be located at its northern aspect, or directly accessible from a living area.

Exemptions:

- For Comprehensive Residential Developments in the Residential (Centres Overlay) Areas, an area of outdoor living space(s) shall be provided for each dwelling on the net site area for that dwelling that meets the following criteria:
 1. Able to accommodate a 'principal area' of 4 metres by 4 metres; and
 2. Is not required for vehicle access, parking or manoeuvring.
- Non-enclosed verandahs, decks, porches, swimming pools, and a glassed conservatory with a maximum area of 13m² may encroach over or into 25% of the outdoor living court.
- For new residential buildings as part Comprehensive Residential Developments in the Urban Precinct of the Wallaceville Structure Plan Area, any dwelling with no habitable rooms at ground level shall have an outdoor living space (such as a balcony or terrace) that is directly accessible from an internal living room with a minimum depth of 2.2m and a minimum area of 10m².

18.14 Building form

Policies 4.4.2,
4.4.4

Where three or more dwellings are attached, a step in plan of at least 3m shall be provided between every second unit, as shown in the following diagram:

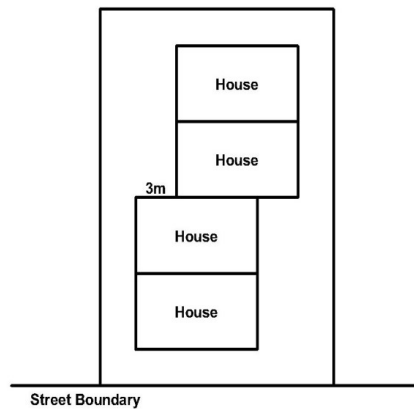

18.15 Building height

*Policies 4.4.2,
4.4.4*

The maximum height of any building shall not exceed 8m.

Exemption:

Chimneys, flues and minor decorative features may exceed the maximum height by up to 1m.

New buildings as part of a Comprehensive Residential Development in the Urban Precinct of the Wallaceville Structure Plan Area where the maximum height of any building shall not exceed 10m

18.16 Sunlight access

*Policies 4.4.2,
4.4.4*

Height control planes apply to all buildings:

- In, or adjacent to, a Residential Zone.
- On sites smaller than 1500m² in a Rural Zone.

Buildings shall be designed so that they fit within the height control planes defined below:

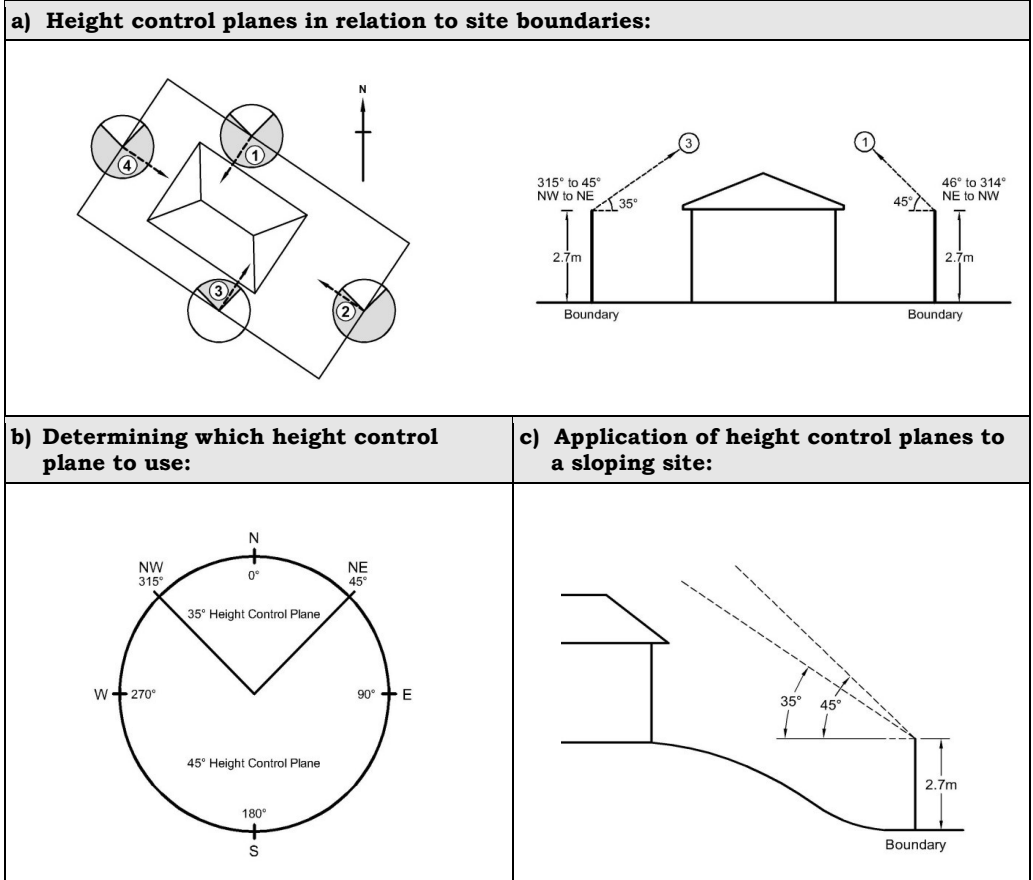

Exemptions:

- Chimneys, flues, and minor decorative features may extend beyond the height control plane by up to 1m.
- The top of a dormer or gable, but not the eaves, may extend beyond the height control plane by up to 0.5m provided that the aggregate length of all projections through the plane does not exceed 25% of the total building length.
- Where the boundary involved in the measurement of the height control plane adjoins an access strip or right-of-way to a rear lot, the outside boundary of such an access strip or right-of-way may be substituted for the nearest site boundary.
- In the Urban Precinct of the Wallaceville Structure Plan Area, for semi-detached dwellings the sunlight access provisions shall not apply on the shared common wall

18.16A

Ventilation

Within the Wallaceville Structure Plan Area, where:

1. sleeping rooms and studies where openable windows are proposed in dwellings within 20m of the Alexander Road boundary or 50m of the rail corridor (designation TZR1); or
2. sleeping rooms and studies in buildings within 50m of a site designated as MAF1;

a positive supplementary source of fresh air ducted from outside is required at the time of fit-out. For the purposes of this requirement, a sleeping room is any room primarily used for sleeping. The supplementary source of air is to achieve a minimum of 7.5 litres per second per person.

18.16B

Noise Insulation

Within the Wallaceville Structure Plan Area, where

1. any sleeping room or study within 12m of the Alexander Road boundary; or
2. any sleeping room or study in dwellings within 30m of a site utilised for railway purposes (Designation TZR1)

shall be protected from noise arising from outside the building by ensuring the external sound insulation level achieves the following minimum performance standard:

$D_{2m,nT,w} + C_{tr} > 35$

Compliance with this rule shall be achieved by either:

1. Constructing the building in accordance with the minimum requirements set out in the attached construction schedule; or
2. Providing to Council's satisfaction a certificate from an experienced acoustic expert stating that the external sound insulation level of the proposed sleeping room or study will achieve the minimum performance standard of $D_{2m,nT,w} + C_{tr} > 35$

Noise Insulation Construction Schedule

(this schedule describes the minimum requirements necessary to achieve an external sound insulation level of $D_{2m,nT,w} + C_{tr} > 35$)

Building Element	Minimum Construction Requirement
<u>External Walls</u>	<p>External cladding with a surface mass not less than 23 kg/m^2, ex 100 x 50 timber framing at 600 mm centres, Fibrous thermal insulation, Internal lining of one layer 13 mm thick high density Gypsum board (minimum 12 kg/m^2).</p> <p>Or: Any wall construction utilising at least 50 mm thick concrete, Secondary timber strapping or wall framing not less than 50 mm thick lined with at least 10 mm thick gypsum board, and, Fibrous thermal insulation</p> <p>Combined superficial density: Minimum not less than 35 kg/m^2 being the combined mass of external and internal linings excluding structural elements (e.g. window frames or wall studs) with no less than 12 kg/m^2 on each side of structural elements.</p>
<u>Glazed Areas</u>	<p>4/12/4 thermal double glazing, with 6 mm thick secondary pane at least 75 mm from the outer glazing</p> <p>Windows to be new aluminium frames with fixed panes or opening sashes with full compression seals.</p> <p>NOTE: Rooms with glazed areas in external walls greater than 35% of <u>floor</u> area of the room will require a specialist acoustic report to show conformance with the insulation rule.</p>
Pitched <u>Roof</u> (all roofs other than skillion roofs)	<p>Profiled longrun steel or tiles, with minimum steel thickness of 0.4 mm, Timber trusses at minimum 800 mm centres, Fibrous thermal insulation, Ceiling lining of one layer 13 mm thick high density Gypsum board (minimum 12 kg/m^2).</p>
Skillion roof	<p>Profiled long-run steel or tiles, with minimum steel thickness of 0.4 mm, Timber framing at minimum 600 centres, Fibrous thermal insulation, Ceiling lining of two layers 13mm thick high density Gypsum board (minimum 12 kg/m^2 each</p>
External <u>Door</u> in outside walls	<p>Solid core door (min 25 kg/m^2) with compression seals (where the door is exposed to exterior noise).</p>

Notes:

- The table refers to common specifications for timber size. Nominal specifications may in some cases be slightly less than the common specifications stated in the schedule for timber size.
- In determining the insulating performance of roof/ceiling arrangements, roof spaces are assumed to have no more than the casual ventilation typical of the jointing capping and guttering detail used in normal construction.

18.16C

Fencing

Within the Wallaceville Structure Plan Area:

- A 1.5m high close boarded fence shall be erected along the boundaries of a site where it adjoins a site designated for railway purposes (Designation TZR1). The fence shall be constructed of materials having superficial mass of not less than 10kg per square metre and shall be constructed prior to the occupation of dwellings on the site
- A 2m high close boarded fence shall be erected along the

boundaries of a site where it adjoins a site designated as MAFL. The fence shall be constructed of materials having superficial mass of not less than 10kg per square metre and shall be constructed prior to occupation of buildings on the site.

- Fences along front yards of sites within the Urban Precinct and Grants Bush Precinct must not exceed a maximum height of 1.5m.
- Within Area B, fences along the boundaries of a site where it adjoins Alexander Road must not exceed a maximum height of 1.8m and the portion of fence over 1.3m must be permeable.

18.17

Policies 4.4.2, 4.4.4, 4.4.5

Accessory buildings

- Accessory buildings shall not be erected within the front boundary setback.
- Any wall closer than 1m from a boundary shall be no longer than 8m, **except** in a Residential (Centres Overlay) Area on a site with a net site area of less than 400m², where any wall closer than 1m from a boundary shall be no longer than 6m.
- The distance between an accessory building and any point of the main window of a habitable room on an adjoining site, measured at right angles to the plane of the window, shall be not less than 3m.

For garages and other accessory buildings which form a part of a dwelling, the standards for accessory buildings shall apply to that dwelling, but only to the area of the dwelling which is an accessory building.

18.18

Water supply, stormwater and wastewater

Policies 9.4.3, 13.4.1

All activities shall comply with the water supply, stormwater and wastewater standards in the Code of Practice for Civil Engineering Works.

18.18A

On-site soakage

Policy 4.4.1

Within a Comprehensive Residential Development an outdoor area of 25m² of water-permeable surface per dwelling shall be provided.

18.19

Artificial light

Policies 4.4.3, 15.4.1

- Light emissions from a site shall not exceed a measurement of 8 lux (lumens per m²) measured in both the horizontal and vertical planes, 1.5m above the ground at the site boundary.

- Light emissions from a site shall not spill directly onto roads.
- Light emissions will be measured by an instrument that meets NZSS CP22 (1962) requirements and amendments.

18.20

Dust

*Policies 4.4.3,
15.4.1, 15.4.2*

Activities shall not create a dust nuisance. A dust nuisance may occur if:

- There is visible evidence of suspended solids in the air beyond the site boundary.
- There is visible evidence of suspended solids, traceable from a dust source, settling on the ground, building or structure on a neighbouring property or on water.

18.21

Screening

*Policies 4.4.2,
4.4.2A, 4.4.3,
4.4.5, 15.4.1*

- a) Outdoor storage areas shall be screened by a close-boarded fence, a solid wall or dense planting of vegetation. The screening shall be no less than 1.8m in height
- b) In relation to the land identified in Area B of Appendix Residential 3, sites which have a south boundary adjacent to Maidstone Terrace shall be screened along that boundary by a close-boarded fence or a solid wall no less than 1.8m in height.

18.22 Home occupations ancillary to residential activities carried out on the site

*Policies 4.4.3,
15.4.1*

- At least one of the persons engaged in the home occupation shall live on the site as their principal place of residence.
- No more than three non-resident persons may be engaged in the home occupation at any one time.
- The repair or maintenance of vehicles or engines, other than those belonging to the residents, is not permitted.
- The site shall not be used as a depot for any heavy vehicle associated with a trade.
- Only goods produced or grown on the site may be sold from the site, provided that no retailing activity shall take place where access is to the State Highway.
- Homestay activities, where accommodation and meals are provided in a family type environment, are permitted provided the total number of persons accommodated on the site at any one time, including persons normally resident on the site, does not exceed twelve.
- Equipment used shall not interfere with radio and television reception.

18.23 Temporary signs

*Policies 4.4.8,
15.4.5, 16.4.4*

Temporary signs, in all zones, must meet all of the following conditions:

- The sign face shall be no greater than 3m² in area visible from any one direction.
- The sign shall relate to a temporary or one-off activity.
- The maximum period for any temporary sign shall be 2 months, except for signs required to be erected for health and safety reasons, where the maximum period shall be 6 months.
- Any temporary sign shall be removed within 48 hours of the ceasing of the activity to which the sign relates.
- Real estate signs involved in the advertising and sale of properties must relate to the property on which they are erected.
- Any sign shall be located so that it does not obstruct any official traffic sign.
- Any sign must not be flashing, animated or continuously differ in form or detail.

- Any sign directed at the State Highway where the speed limit is 70km/hr or greater shall comply with the following:
 - Have a minimum letter height of 160mm; and,
 - Contain no more than six words and symbols and no more than 40 characters; and,
 - Be located so as to provide an unrestricted view to the motorist for a minimum distance of 180 metres.

18.24 Signs within roads

Policies 4.4.8, 15.4.5, 16.4.4

Road, traffic and advertising signs within roads, in all zones, must be approved by the road controlling authority.

18.25 All other signs

Policies 4.4.8, 15.4.5, 16.4.4

One sign per site with a maximum face area of 1.5m² visible from any one direction.

- Any sign shall be situated on the site to which the sign relates.
- Any sign must not be flashing, animated or continuously differ in form or detail.
- Any sign shall be removed when the activity to which it relates has ceased.
- Any sign shall be located so that it does not obstruct any official traffic sign.
- Any sign directed at the State Highway where the speed limit is 70km/hr or greater shall comply with the following:
 - Have a minimum letter height of 160mm; and,
 - Contain no more than six words and symbols and no more than 40 characters; and,
 - Be located so as to provide an unrestricted view to the motorist for a minimum distance of 180 metres.

18.26 Marae

Policies 4.4.3, 4.4.6

Council may impose conditions over the following matters:

- Bulk, location, appearance and design of the buildings.
- Design and layout of car parking, loading, manoeuvring and access areas.
- Provision of and effects on utilities and/or services.
- Landscaping, including the retention of existing trees.
- Hours of operation.
- Financial contributions.

18.27 Relocated Buildings

Policy 4.4.2

Council may impose conditions on:

- a) Reinstatement works to the condition and appearance of the building relating to:
 - Works to the exterior fabric of the building to repair, replace or renovate damaged, defective or substandard elements;
 - Painting and/or cleaning of the exterior fabric of the building if necessary;
 - Cladding or other means of enclosing open subfloor areas below the building;
 - Alterations required to ensure that the reinstated exterior of any relocated building is not likely to detract from the amenity values of the surrounding area.
- b) The timeframe for the work to be completed;
- c) Landscaping, screening and boundary treatment;
- d) Execution of a performance bond to provide security for exterior reinstatement works required as a condition of resource consent;
- e) Provision of and effects on utilities and/or services;
- f) Standard, construction and layout of vehicular access.

Notes in respect of d):

- A bond is not mandatory. It will only be required when Council considers it necessary in view of the scale and/or nature of exterior reinstatement works required. The requirement for a bond and its value will be determined in the context of the building assessment report submitted at resource consent stage.
- The bond shall be executed at the time application is made for a building consent, and security shall be in the form of either money or a guarantee by an institution approved by Council as guarantor.
- The bond shall be cancelled upon completion of exterior reinstatement works required in the conditions of the resource consent. The verification method for completion of these works shall be the issuing of a full or interim Code Compliance Certificate as defined in the Building Act. In the event that conditions relating to exterior reinstatement works are not complied with, the bond may be used in whole or in part to complete the works.

Restricted Discretionary Activities

18.28A Comprehensive Residential Development

Policies 4.4.1,
4.4.2, 4.4.4,
4.4.12, 4.4.13,
16.4.3

Note: Comprehensive Residential Development within Residential (Centres Overlay) Areas is not subject to the minimum net site area requirements of rule 18.10

Standards and terms for Comprehensive Residential Development:

- Compliance with the access standards of rule 18.9.
- Compliance with the site coverage standard of rule 18.11.
- Compliance with the yard setback standards of rule 18.12 and 18.17 for external boundaries only.
- Compliance with the outdoor living court standard of rule 18.13
- Compliance with the maximum building height standard of rule 18.15.
- Compliance with the sunlight access planes of rule 18.16 for external boundaries only.
- Compliance with the on-site soakage standard of rule 18.18A.

Additional standards and terms for Comprehensive Residential Development within the Wallaceville Structure Plan Area:

- Compliance with noise insulation and ventilation standards of rule 18.16A and 18.16B
- Compliance with the fencing standards of rule 18.16C

For subdivision of a Comprehensive Residential Development under Rule 18.1, Council's discretion is also limited to the matters specified in this rule, but not the standards and terms.

Council will restrict its discretion to, and may impose conditions on:

- Site layout, design and external appearance.
- Provision of and effects on network utilities and/or services.
- Landscaping.
- Standard, construction and layout of vehicular access.
- Protection of any special amenity feature.
- Financial contributions.
- The outcome of consultation with the owner or operator of regionally significant network utilities (excluding the National Grid) located on or in proximity to the site.

Note: Rule 18.29 covers subdivision within the Electricity Transmission Corridor.

In relation to the land identified in Appendix Residential 3, Council will restrict its discretion to and may impose conditions over the following matters:

- The measures necessary to address the interface of any residential development with both Maidstone Park and the Business Industrial Zone. These may include, but are not limited to:
 - the orientation of dwellings and the location of habitable rooms relative to Maidstone Park and adjacent Business Industrial zoned properties;
 - the orientation of buildings, fences, or landscaping to buffer outdoor living spaces from adjacent Business Industrial zoned properties.

In considering a resource consent application, Council's discretion is also restricted to an assessment against the Design Guide for Residential (Centres Overlay) Areas (refer to Appendix Residential 2) and, where relevant, the Wallaceville Structure Plan (refer Chapter 39: Wallaceville).

Restriction on notification

In respect of rule 18.28A, and subject to sections 95A(2)(b), 95A(4) and 95C of the Act, an application which meets the standards and terms of rule 18.28A will be decided without the need for public notification under section 95A, but limited notification of an application will still be determined in accordance with section 95B. The restriction in respect of public notification does not apply if the application requires land use consent under any other provision of the Plan.

For Comprehensive Residential Development in the Wallaceville Structure Plan Area, in respect of rule 18.28A, and subject to sections 95A(2)(b), 95A(4) and 95C of the Act, an application which meets the standards and terms of rule 18.28A will be decided without the need for public notification under section 95A and any application that is consistent with the Wallaceville Structure Plan will be decided without the need for limited notification under section 95B.

Note:

- a) A Comprehensive Residential Development that does not comply with the standards and terms of this rule, will be assessed against the matters set out in Rule 18.37.
- b) Notwithstanding 18.28A any Comprehensive Residential Development on land identified in Appendix Residential 3 that does not comply with 18.5, 18.8A, and 18.9, 18.12 and/or 18.21 (b) is a non-complying activity.

18.28B

Subdivision within the Wallaceville Structure Plan Area

Standards and terms for Subdivision in the Wallaceville Structure Plan Area

- Compliance with the access standards of rule 18.9
- Compliance with the minimum requirements for subdivision of rule 18.5

Council will restrict its discretion to, and may impose conditions on:

- The extent to which the subdivision is consistent with the Wallaceville Structure Plan (Chapter 39: Wallaceville)
- The extent to which the subdivision is consistent with the spatial layout plan for Area B required under Section 1.8.5.3
- Design, appearance and layout of the subdivision
- Landscaping that complements existing species
- Standard, construction and layout of roads (including intersections) and vehicular access.
- Provision of and effects on utilities and/or services.
- Earthworks and land stability
- Provision of reserves
- Protection of any special amenity feature
- Provision of pedestrian and cycleway connections
- The alignment of proposed subdivision boundaries with Precinct boundaries as identified in the Wallaceville Structure Plan
- Financial contributions

Restriction on notification

In respect of rule 18.28B, and subject to sections 95A(2)(b), 95A(4) and 95C of the Act, an application which meets the standards and terms of rule 18.28B will be decided without the need for public notification under section 95A and any application that is consistent with the Wallaceville Structure Plan will be decided without the need for limited notification under section 95B.

Notes:

- Failure to comply with this rule will require resource consent as a Discretionary Activity
- A resource consent application for subdivision consent under this rule shall contain the information listed in 1.8.4 in addition to the requirements of the Fourth Schedule of the Resource Management Act 1991. Where relevant, applications may rely upon any spatial layout plan submitted as part of a prior subdivision application that has received consent

18.29 Subdivision which creates building platforms within 20m of high voltage (110kV or greater) electricity transmission lines as shown on the Planning Maps

Policies 16.4.1, 16.4.7

In addition to the matters listed in rule 18.6, Council will restrict its discretion to, and may impose conditions on:

- The extent to which the subdivision design manages potential conflicts with existing lines by locating roads and reserves under the route of the line.
- The extent to which maintenance and inspections of transmission lines are affected including access.
- The extent to which potential adverse effects including risk or injury, property damage and visual impact are mitigated through the location of building platforms and landscaping.
- The outcome of any consultation with the affected utility operator.
- Separation distances between trees and conductors and the location and mature size of trees planted near the transmission lines.
- Compliance with the New Zealand Electrical Code of Practice for Electrical Safe Distances 2001 (NZECP 34:2001).
- Measures necessary to avoid, remedy or mitigate the potential adverse effects of earthworks, dust generation and construction activities, including provision of appropriate separation distances, managing the risks to structural integrity, and safety risks associated with the use of mobile machinery.

Restriction on notification

Subject to sections 95A(2)(b), 95A(2)(c), 95A(4) and 95C of the Act, a resource consent application under this rule will be precluded from public notification under section 95A, and limited notification will be served on Transpower New Zealand Limited as the only affected party under section 95B.

18.30 Subdivision and land use activities which do not comply with the access standards in 18.9

Policy 16.4.6

Council will restrict its discretion to, and may impose conditions on:

- The extent to which the activity will adversely affect traffic and pedestrian safety.
- The extent to which the activity will adversely affect the efficient functioning of the roading network.

For subdivision, Council's restriction is also restricted to the matters listed in rule 18.6

18.31 Buildings or structures within 12-20m of high voltage (110kV or greater) electricity transmission lines as shown on the Planning Maps

Policy 16.4.7

Council will restrict its discretion to, and may impose conditions on:

- a) Compliance with the New Zealand Electrical Code of Practice for Electrical Safe Distances 2001 (NZECP 34:2001).
- b) The location, height, scale, orientation and use of buildings and structures to ensure the following are addressed:
 - The risk to the structural integrity of the transmission line.
 - The effects on the ability of the transmission line owner to operate, maintain and upgrade the transmission network.
 - The risk of electrical hazards affecting public or individual safety, and risk of property damage.
 - The extent of earthworks required, and use of mobile machinery near the transmission line which may put the line at risk.
 - Minimising the visual effects of the transmission line.
 - The outcome of any consultation with the affected utility operator.

Restriction on notification

Subject to sections 95A(2)(b), 95A(2)(c), 95A(4) and 95C of the Act, a resource consent application under this rule will be precluded from public notification under section 95A, and limited notification will be served on Transpower New Zealand Limited as the only affected party under section 95B.

18.32 Family flats which do not comply with the permitted activity standards

Policies 4.4.2,
4.4.4

Council will restrict its discretion to, and may impose conditions on:

- Land tenure.
- Location.
- Provision of and effects on utilities and/or services.
- Landscaping.
- Setbacks and coverage.
- Height and sunlight access.
- Standard, construction and layout of vehicular access.
- Effects on character and amenity.
- Financial contributions.

18.33 Home occupations ancillary to residential activities carried out on the site which do not comply with the permitted activity standards

Policies 4.4.3, 4.4.6

Council will restrict its discretion to, and may impose conditions on:

- External storage.
- The number of non-resident workers employed on the site.
- The creation of dust, light, noise, vibration or other nuisance.
- Appearance of buildings.
- Size, number of location and appearance of signs.
- Car parking, traffic and pedestrian safety and the efficient functioning of the roading network.
- Financial contributions.

18.34 Buildings accessory to permitted and controlled activities which do not meet permitted or controlled activity standards

Policies 4.4.2, 4.4.4, 4.4.5

Council will restrict its discretion to, and may impose conditions on:

- Height and sunlight access.
- Setbacks and coverage.
- Landscaping and screening.
- Provision of and effects on utilities and/or services.
- Standard, construction and layout of vehicular access, manoeuvring and traffic safety.
- Streetscape effects.
- Effects on neighbourhood character and amenity.
- Financial contributions.

18.35 Signs which do not comply with the standards for permitted activities

Policies 4.4.8, 15.4.5, 16.4.4

Council will restrict its discretion to:

- Whether the sign is in scale with the associated activities or building development and compatible with the visual character of the area in which it is situated.
- Whether signs are obtrusively visible from any residential area or public space.
- Whether signs will have adverse effects on traffic or pedestrian safety.
- Whether signs detract from the appearance of the building to which they are attached.
- Whether signs will result in additional clutter.

Council may impose conditions on:

- The area of signs.
- The number of signs.
- The colour and materials used.
- The location of signs.
- Sign content.
- Illumination, lighting, reflectorisation and animation.

18.36 Early childhood centre(s)

Policies 4.4.3, 4.4.6, 4.4.7

Council will restrict its discretion to, and may impose conditions on:

- Location of the proposed early childhood centre.
- Bulk, location, appearance and design of the buildings.
- The extent to which the proposal will adversely affect traffic and pedestrian safety, and the efficient functioning of the roading network.
- Design and layout of car parking, loading, manoeuvring and access areas.
- Provision of and effects on utilities and/or services.
- Landscaping, including the retention of existing trees.
- Hours of operation.
- Financial contributions.

Restriction on notification

Subject to sections 95A(2)(b), 95A(2)(c), 95A(4) and 95C of the Act, a resource consent application for an early childhood centre will be precluded from public notification under section 95A, but limited notification of an application will be determined in accordance with section 95B.

18.37

Subdivision within the ponding area of the Pinehaven Flood Hazard Extent, which creates any undeveloped lots that do not contain a dwelling and complies with the requirements of Rule 18.5

Policy 9.4.4.
Policy 9.4.5

Standards

- Suitable future building platform area must be identified and must not be located within an overflow path, or stream corridor.

Council will restrict its discretion to, and may impose conditions on:

- The matters listed in Rule 18.6.
- The appropriateness of the proposed building platform in terms of area and location in relation to the flood hazard.
- Ability for a future dwelling to be constructed above the 1 in 100-year flood level.
- The effect of the future development of the building platform on the Pinehaven flood hazard extent.
- Consent notice restricting the future development to the identified platform.
- Matters addressing the standards for access under Rule 18.9 where any standards are not met.

18.38

Subdivision of a site within the Pinehaven Catchment Overlay is a Restricted Discretionary Activity.

Policy 9.4.10

Standards

- Achieves hydraulic neutrality.
- Provision of a report by a suitably qualified and experienced person providing an assessment of the ability for the site to achieve hydraulic neutrality in accordance with the requirements of 1.8.11.
- Compliance with the standards of Rule 18.5.

Council will restrict its discretion to, and may impose conditions on:

- The matters listed in Rule 18.6
- Ability for the subdivision and proposed design to ensure peak flow of stormwater discharge will be no greater than pre-subdivision levels and thus achieve hydraulic neutrality.

- The effect of the subdivision on the Pinehaven Flood Hazard Extent.
- Recommendations and mitigation measures of the hydraulic report.
- Consent notice restricting the future development of the lot to the design and recommendations of the hydraulic neutrality report.
- Matters addressing the standards for access under Rule 18.9 where any standards are not met.

18.39

Subdivision within the Ponding Area or Erosion Hazard Area of the Mangaroa Flood Hazard Extent, which results in any undeveloped lots that contain no dwelling or non-residential building, and complies with the requirements of Rule 18.5

Policies 9.4.4.
9.4.5

Standards

- Suitable future building platform area must be identified and must not be located within the River Corridor.
- Where located within the Erosion Hazard Area, provision of a report by a suitability qualified and experienced person assessing the erosion risk to the proposed building platform in accordance with the requirements of 1.8.10.

Council will restrict its discretion to, and may impose conditions on:

- The matters listed in Rule 18.6;
- The appropriateness of the proposed building platform in terms of area and location and erosion risk in relation to the flood hazard.
- Ability for a future dwelling to be constructed above the 1 in 100 year flood level.
- The effect of the future development of the building platform on the function of the floodplain.
- Consent notice restricting the future development to the identified platform.
- Matters addressing the standards for access under Rule 18.9 where any standards are not met.

Matters for Consideration

18.40

Matters that may be relevant in the consideration of any Discretionary or Non-Complying Activity resource consent may include the following:

Subdivision
<ul style="list-style-type: none"> • The requirements of section 106 of the Act. • Whether the proposed allotments are capable of accommodating a range of activities in compliance with zone standards. • Whether the subdivision compromises future subdivision potential of the land. • The cumulative effect on existing infrastructure as a result of the proposed subdivision. • The extent of compliance with the Council’s Code of Practice for Civil Engineering Works. • For subdivisions with a net site area less than 400m² located in a Residential (Centres Overlay) Area, the extent to which the proposal meets the requirements for ‘small site design and development’ of the Design Guide for Residential (Centres Overlay) Areas; • For subdivisions of a Comprehensive Residential Development, the extent to which the proposal meets the requirements of the Design Guide for Residential (Centres Overlay) Areas. • The design and layout of the subdivision where any lot may affect the safe and effective operation and maintenance of, and access to, regionally significant network utilities (excluding the National Grid), located on or in proximity to the site. • The outcome of consultation with the owner or operator of regionally significant network utilities (excluding the National Grid) located on or in proximity to the site. Note: Rule 18.29 covers subdivision within the Electricity Transmission Corridor. • The design and layout of the subdivision where any lot may affect the safe and effective operation and maintenance of, and access to, consented or existing renewable energy generation activities located on or in proximity to the site. • The outcome of consultation with the owner or operator of consented or existing renewable energy generation activities located on or in proximity to the site. • Account must be taken of the future development potential of adjoining or adjacent land. • Account must be taken of any potential reverse sensitivity effects on regionally significant network utilities (excluding the National Grid). • Where located within an identified flood hazard extent, any relevant restricted discretionary activity matters for subdivision.
Site layout, area and coverage
<ul style="list-style-type: none"> • The arrangement of buildings, car parking and vehicle movements on site. • The extent of landscaping and screening. • Whether the topography of the site has been taken into account. • Whether a better standard of development can be achieved by varying the design standards. • The ability to provide adequate outdoor living areas. • The extent to which decreases in site size or increased site coverage would have an adverse effect on the amenity of the area.

Bulk and location of buildings
<ul style="list-style-type: none"> • Whether the buildings will cause a loss of privacy, interfere with sunlight access or create shadows on surrounding allotments. • Whether the building location, design, appearance and scale will detrimentally affect the character of the surrounding area.
Comprehensive Residential Development
<ul style="list-style-type: none"> • The extent to which the proposal meets the guidance for Comprehensive Residential Developments included in the Design Guide for Residential (Centres Overlay) Areas. • Matters listed under 'Site layout, area and coverage' in this rule. • Matters listed under 'Bulk and location of buildings' in this rule. • Matters listed under 'Sunlight access' in this rule. • Matters listed under 'Traffic generation and access' in this rule.
Development of two or more dwellings with a net site area less than 400m² in Residential (Centres Overlay) Areas that is not otherwise a Comprehensive Residential Development
<ul style="list-style-type: none"> • The extent to which the proposal meets the guidance on small site design and development contained in the Design Guide for Residential (Centres Overlay) Areas.
Traffic generation and access
<ul style="list-style-type: none"> • Accessibility for public transport, cyclists and pedestrians. • Whether activities which generate significant traffic flows have the necessary access, do not adversely impact upon the street environment, and maintain public safety.
On-site soakage
<ul style="list-style-type: none"> • Whether there are any factors that limit or preclude the provision of on-site soakage, and the extent to which any reasonable alternatives to providing on-site soakage have been explored.
Sunlight access
<ul style="list-style-type: none"> • Whether the building will adversely interfere with sunlight access or create adverse shading on surrounding sites. • Whether the topography of the site or the location of any built features on the site or other requirements, such as easements, impose constraints that make compliance impracticable.
Non-residential activities
<ul style="list-style-type: none"> • Whether the buildings, structures or other works are of a compatible scale having regard to the local environment and the nature of the surrounding development. • The extent to which the amenity values and the quality of the residential environment can be maintained and enhanced.
Signs
<ul style="list-style-type: none"> • Whether the sign is in scale with the associated activities or building development and compatible with the visual character of the area in which it is situated. • Whether signs are obtrusively visible from any residential area or public space. • Whether signs will have adverse effects on traffic or pedestrian safety. • Whether signs detract from the appearance of the building to which they are attached. • Whether signs will result in additional clutter.

Work on trees in the Residential Conservation and Residential Hill Sub-zones
<ul style="list-style-type: none"> • The contribution the tree makes to the amenity of the area. • The health of the tree. • The function the tree may have in an ecosystem or habitat. • Whether the tree is causing or is likely to cause significant damage to buildings, structures or utilities. • Significant adverse environmental effects caused by the tree and the nature of works proposed to avoid, remedy or mitigate them.
Hours of operation
<ul style="list-style-type: none"> • The nature, extent and duration of noise and traffic effects from active recreation.
Nuisance
<ul style="list-style-type: none"> • The potential impacts of noise, dust, glare, vibration, fumes, smoke, other discharges or pollutants or the excavation or deposition of earth.
Infrastructure
<ul style="list-style-type: none"> • The capacity of the infrastructure.
Cumulative effects
<ul style="list-style-type: none"> • Whether cumulative effects such as pollution, risk to public safety and nuisances have been assessed.
Subdivision and/or development in the Wallaceville Structure Plan Area
<ul style="list-style-type: none"> • Relevant matters in the sections above
<ul style="list-style-type: none"> • The extent to which the subdivision and/or development is consistent with the Wallaceville Structure Plan
<ul style="list-style-type: none"> • The extent to which any subdivision and/or development that is not consistent with the Wallaceville Structure Plan will avoid, remedy or mitigate adverse effects on other areas of Upper Hutt City, does not detract from the vitality and vibrancy of the Upper Hutt CBD, will adequately provide for stormwater management, will contribute to the safe functioning of the road network and will integrate with adjoining development anticipated through the Structure Plan

Appendix Residential 1

99-105 Blue Mountains Road.



Appendix Residential 2

Residential (Centres Overlay) Area Design Guide

Design Guide for Residential (Centres Overlay) Areas

The Design Guide

The purpose of the design guide is to provide design criteria that will direct the delivery of well designed, good quality higher density housing in an Upper Hutt-specific context. The guide applies specifically to Comprehensive Residential Development and subdivision that produces small lots. These developments, because of their higher density and potential effect on residential amenity, will require resource consents. Applications will be required to demonstrate how the design of the development has addressed the criteria in this Design Guide, in addition to meeting the relevant standards and objectives and policies of the District Plan.

This design guideline is structured in three parts. The first focuses on the specific requirements of Comprehensive Residential Developments and the second concentrates on small site design – most relevant to infill style subdivision, or developments of small scale stand-alone dwellings. The two parts should be read as a whole, and the guidance provided should be considered to achieve improved urban outcomes for all forms of residential development.

The third part of the Design Guide contains Character Statements for the Residential (Centres Overlay) areas, to assist in understanding the elements of character in those areas and responding positively to the Design Guide with these in mind.

What is Comprehensive Residential Development?

Comprehensive residential development is a way of providing a greater degree of choice in housing in Upper Hutt. It involves developing sites in a planned and efficient way with a greater density of housing than has been done in the past. It delivers an alternative to traditional development patterns of houses on large sections, and is a way to make efficient use of land while still providing houses that are attractive, private and often, more affordable to buy and through improved design, providing lower cost of living. Different forms of housing also provide choice for those who do not want or need larger houses or sections, especially if they wish to remain in a community they have come to like.

Across the residential areas of Upper Hutt, several areas called Residential (Centres Overlay) Areas have been specifically identified as suitable locations for this sort of development to occur. These areas are in proximity to local amenities and public transport, and are ideal locations for housing developments at a greater density

As density increases, more thought needs to be given to creating good quality living spaces alongside pleasing streets and townscape. Higher density housing is often thought to lead to poor urban quality, overcrowding and reduced space standards. However, poor quality outcomes are often a result of poorly conceived or inflexible design rather than just increased density. The best sorts of outcomes are achieved by examining context and designing a carefully considered, specific solution for each site.

The design of higher density residential development needs to respond to the qualities of the street and the area, and to provide for the needs of the inhabitants. Good quality housing will meet current and future demand, and cater for the needs of the city's changing population.

Aims for comprehensive residential developments:

- Houses and open space are located and arranged on the site in an integrated and comprehensive manner.
- New development contributes positively to the character of the neighbourhood.
- Reasonable privacy for the residents and neighbours is provided through well considered siting and design of buildings.

- Housing provides a high quality and efficient living environment (both internal and external) for occupants.

Note: Where a development incorporates an existing house(s) the requirements of this Guide shall apply equally to that house(s).

What is a 'small site'?

Within the Residential (Centres Overlay) Areas, the District Plan provides for a lower minimum net site area than in other residential areas.

Such small lots present design challenges, and simply 'miniaturising' more commonly seen forms of development may not produce the best outcomes for amenity either on-site or for the wider area. A careful approach is needed to ensure that small lots continue to create sites that are both developable, and able to accommodate houses that are well-designed and afford good amenity to occupants.

Aims for small site design:

- Lots are of an adequate width and suitable shape to accommodate a residential dwelling.
- Lots are oriented for access to sunlight and to take advantage of solar gain to internal spaces.
- Lots are designed to ensure that useable outdoor space will be readily accessible from future dwelling sites.
- Lots are laid out and designed, and building sites identified, so as to provide for the retention of significant trees and vegetation.
- Access to lots is designed so as to minimise its visual impact and dominance.
- Lots and dwelling sites are located and shaped to minimise adverse impact on existing development surrounding the site, and potential future development.

COMPREHENSIVE RESIDENTIAL DEVELOPMENTS

Integrated Buildings and Spaces

As housing density increases there is a corresponding need to make sure that buildings are arranged carefully across sites and that spaces around them fulfil useful and sensible functions. In Upper Hutt, the sense of space around buildings is valued as part of the townscape, so new developments should aim to enhance this wherever possible.

However, this does not mean that all houses need to be physically separate and have space on all sides. Well-designed attached housing can provide both on-site amenity and value to the wider area, by employing careful consideration of how buildings are arranged and outdoor spaces are allocated from the outset of the design process. The ability to accommodate landscaping on-site (particularly vegetation that grows to a mature height above fence level) will also have an impact on both the sense of spaciousness around houses and the character of the wider neighbourhood.

How vehicles are accommodated on sites also has an impact on amenity outcomes. Site design should aim to consider buildings, the spaces surrounding them, vehicles and landscaping as part of a comprehensive whole at the outset of the design process.

Guidelines

- The siting of buildings and open space should be designed in an integrated way so that buildings can connect with useful outdoor space that has reasonable privacy, good access to sunlight, and a sense of openness. (See figure 1)

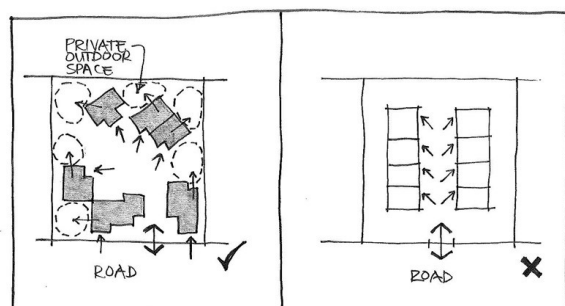

Figure 1: Carefully considered layout of buildings on sites helps to contribute to a more pleasant living environment.

- Each unit should have its own private outdoor space, for use exclusively as outdoor recreational space. Shared spaces as the principal means of providing outdoor living areas will only be considered in special circumstances.

Outdoor space within the site needs to be planned for at the design stage to ensure it is useable rather than residual to the buildings. It also needs to be easily accessible and connected to main living areas, and should not have any part of its area used for any other required function for the site i.e. as part of the on-site parking or manoeuvring requirements.

Shared spaces may be considered in situations such as for comprehensively planned elderly persons' housing, sheltered/community housing or papakainga. Such instances will be individually assessed to ensure the space provided is of the best quality possible and will meet the specific needs of residents, while also ensuring reasonable privacy to interior living spaces.

- The outdoor living area allocated to each dwelling should have within it a 'principal area' that is:
 - Directly accessible from the main indoor living area of that dwelling;
 - Positioned to have regard to shelter from the prevailing wind, or be detailed so as to minimise the worst effects of that wind;
 - Oriented with a northerly aspect to take advantage of natural sunlight;
 - Able to accommodate a square of 4m x 4m;
 - Nominally flat, with a gradient of no greater than 1 in 12;
 - Not located between the dwelling and any public street.

The allocation of a 'principal area' within the overall requirement of outdoor living space ensures that a minimum amount of the outdoor space for a dwelling is carefully considered, and of the highest quality for usability, access and privacy. Although one larger space is preferred, two or more smaller spaces will be considered acceptable where it is possible to demonstrate that this leads to a better outcome in terms of providing quality, useable outdoor living space. (See figure 2)

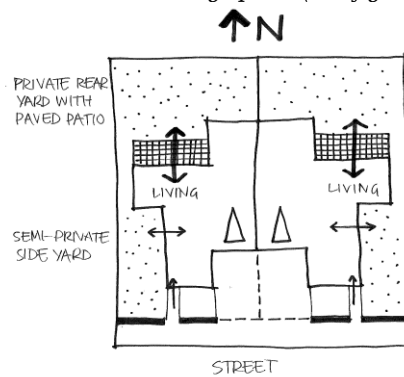

Figure 2: Different types of spaces can all contribute to creating a pleasant outdoor living environment.

- Landscaping of outdoor spaces should be comprehensively planned as part of the overall site design from an early stage.

Landscaping can play a role in helping to define spaces on a site. Landscaping plans should ideally be submitted as part of a resource consent application so the outcomes can be considered as part of a comprehensive whole.

- Where units are at first floor level or above, balconies or roof terraces may be appropriate to provide for outdoor space, subject to careful consideration of privacy. If adequate privacy cannot be obtained by orientation of the spaces or the placement of windows, screening should be used.
- Where there are common outdoor areas on a site, these should connect with the built development by ensuring windows overlook the space, doors to units open on to the space and the dominance of the area by garage doors or parked cars is avoided.

Common areas or shared spaces can contribute positively to the enjoyment of a development. They can be used for meeting places, barbeque areas and a place to kick a ball around. These spaces can be made more enjoyable and safe if people inside units can oversee activity in them. The dominance of cars within these areas will detract from their ability to be used for these activities and the amenity of the development.

- Outdoor rubbish, clothes drying, recycling and storage space should be located so that these facilities are not visually obtrusive, are not located within the 'principal area', do not dominate the entry to residences and are easily accessible to the unit which they serve.

Rubbish enclosures and storage can detract from the appearance of the development and the neighbourhood as well as the amenity of outdoor spaces and as with most existing houses, is most appropriately located in less visible areas and away from locations used for outdoor living.

Outdoor rubbish areas should be screened if they are located within sight of the principal outdoor area.

For terraced houses, where front yard rubbish/recycling storage may be the most appropriate to avoid the need to move these items through the interior of the house, a carefully designed enclosure with adequate ventilation, incorporated into the overall landscaping plan, will usually be the best solution.

Fitting in with the neighbourhood

Many areas of Upper Hutt have a well-developed sense of character. Much of the city's residential area (and the locations in which redevelopment is most likely to occur) is located on the flat valley floor. Older housing stock is often single storey, set back from the street edge and located near the centre of a large rectangular site. Housing displays a wide variety of architectural styles, and mature vegetation contributes to the sense of established neighbourhoods.

Comprehensive residential developments will introduce housing at a greater density into established neighbourhoods. In order for this to be successful, the essential elements of character in a neighbourhood must be understood, and where those elements create a positive contribution, they should be respected (but not necessarily replicated) in the new design. Understanding the key building patterns of the area will help guide new development so that it can sit comfortably within an established area and retain the amenity enjoyed by the neighbourhood and its residents.

Guidelines

- The siting and layout of buildings should respect the existing character and building patterns of the neighbourhood. This pattern may consist of the distance of elements such as front yard setbacks, the spacing between buildings, height and width of buildings, materials used, and types of buildings.

Respecting existing patterns in new development can be demonstrated by adopting similar patterns while not necessarily exactly replicating the detailed design of buildings in the neighbourhood. (See figure 3).



Figure 3: New houses respect the patterns set by existing ones.

- Where the development is in an area of single houses on single sites, the greater building bulk associated with comprehensive residential development should be arranged in terms of layout and form to relate to the scale of the neighbouring housing. This may be achieved by:
 - Modulating the appearance of larger buildings by using setbacks in alignment;
 - Varying the roof design to reduce the perception of bulk;
 - Varying the size of units to reflect the variation of house size in the neighbourhood, where this exists;
 - Varying the height and form of units to avoid a large or dominant form at the boundary;
 - Using complementary/contrasting materials or colours on exteriors to relieve the appearance of bulk;
 - Retaining existing mature trees and vegetation on the site, where possible, to assist the integration of the new development within the site and the neighbourhood.

New developments can fit into existing neighbourhoods by paying attention to existing details and patterns.

Mature trees benefit neighbourhood amenity beyond the development site and are often highly valued by the community. Unless they unreasonably hinder development or are in poor health they should be retained.

- Dwellings within a larger development should be designed and detailed to provide a sense of individuality, and provide opportunities for personalisation.

Most people like to identify their homes by some sense of individuality and this also adds to the visual interest of the development. Where design elements are replicated across a development, providing opportunities for individualisation of houses is important.

- Sites with wide frontages should have more than one connection to the adjoining road.

Vehicle and pedestrian access to sites in most established neighbourhoods is provided at regular intervals along the street edge. The benefits of this are providing good access to and from the street, and creating interesting and active 'fronts' along the street edge. Sites with wide frontages (or amalgamated sites) with shared/fewer driveways need to be carefully considered to ensure that the design will continue to provide these benefits. (See figure 4).

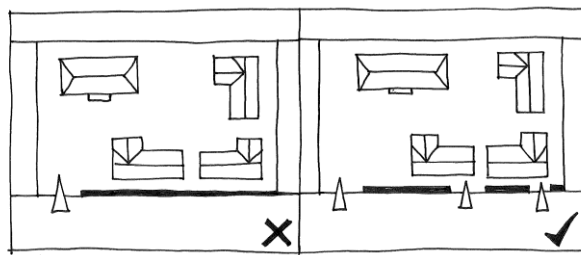

Figure 4: Multiple entrances activate site edges

- Houses on corner lots with frontage to two roads should be designed to provide interest and opportunities for passive surveillance on both facades.

Buildings on corner sites should have one front/primary façade facing the street. Attention should be given to ensuring that the other street-facing façade does not present a blank wall to a public space. Secondary facades could include things like bedroom or dining room windows.

- Dwellings and garages should be designed so that blank walls do not face the street. Any other large surfaces facing the street (e.g. fences) should be either minimised or suitably modulated.

Large blank walls usually have a detrimental effect on streetscape. While being generally unattractive to look at, they also restrict opportunities for passive surveillance of public spaces.

- Where an existing dwelling is proposed to form a part of a Comprehensive Residential Development, consideration should be given to the integration of the existing dwelling into the development through the specific consideration of the factors outlined in this section.

Whilst an existing dwelling can form a part of a Comprehensive Residential Development, this may not always be desirable where the existing dwelling cannot be adequately integrated into the proposed development. Factors such as architectural style, bulk and form, and the use of particular materials may affect the ability of a dwelling to be integrated.

Accommodating vehicles on sites

The accommodation of vehicles on sites can have a significant impact on external amenity. Driveways and paving, garages and garage doors all have the potential to dominate if not carefully considered with the view to minimising visual impact.

Driveways and paved areas within larger developments should be designed and detailed so that they are able to function more like 'shared spaces', where vehicles and people have equal priority. This will ensure that both visual amenity and vehicle and pedestrian safety are enhanced.

Note: The Code of Practice for Civil Engineering Works gives the specific technical requirements relating to the length, width, gradient and other geometric and construction aspects of driveways and parking spaces. Once these have been met, consideration should be given to the following guidelines.

Guidelines

- Accessways and vehicle manoeuvring spaces should be designed to ensure cars enter and leave the site slowly.

To ensure the safety of people within the development, it is important that the layout and landscaping requires vehicles to move slowly within the area and when coming and going. Areas used by cars should be designed so that it is clear to drivers that the spaces are shared with other activities.

- Open parking or vehicle manoeuvring areas should be designed and landscaped as an integral part of the development.
- Expanses of driveway and access areas should be relieved by contrasting patterns and materials to give interest, moderate the apparent scale of paving and add to the visual quality of the development.

Reducing the dominance of vehicle paving is particularly important on larger sites, and on narrow sites where a greater proportion of the width of the site must be dedicated to access and manoeuvring. Long driveways should be detailed with contrasting paving to break up the expanse of hard surfacing.

- The layout of buildings on the site should ensure that garages and car parking spaces are not visually dominant on either the street frontage or within the site.

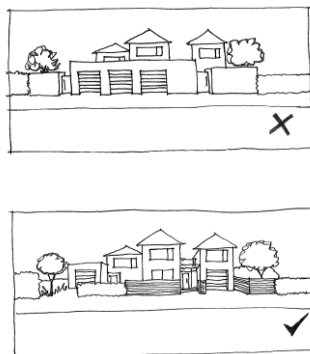

Figure 5: Eliminating blank walls and rows of garages creates a more pleasant streetscape.

A row of garages at the street edge tends to block visibility between the buildings and the street. This usually has a negative impact on a site's attractiveness and reduces the

ability of the residents to oversee the street and thereby contribute to the safety and liveliness of the area. The monotony of a line of garages can also conflict with the pattern of existing development. (See figure 5).

- The design and materials of carports and garages should be integrated into the design of the overall development.

Garages should not be regarded as separate from the development or of lesser design importance.

- Car parking spaces and garages should be conveniently located for the dwelling they serve.
- Any open parking spaces not allocated to a dwelling should have adequate passive surveillance.

Open parking areas and visitor parking needs to be both convenient and safe.

- Access and circulation paths around the site should take into account the need to accommodate rubbish and recycling on collection days, without creating danger or nuisance to either pedestrians or vehicles.

Privacy and Safety

Residential privacy is a valued commodity in Upper Hutt. Past development patterns characterised by single-storey houses located near the centre of large flat sites, with outdoor space to the rear means that many houses enjoy high levels of both visual and acoustic privacy within both the dwelling and typically, for the rear yard.

Medium density housing can be well-designed to protect privacy both within the development site and to adjacent sites. Careful consideration of the placement of doors, windows and internal uses within the dwelling can continue to maintain highly reasonable levels of privacy while still allowing a pleasant outlook, opportunities for passive surveillance and adequate opportunities for solar gain.

Guidelines

- Front doors should be oriented to face the street where possible, or to face common areas within the development.
- Position windows adjacent to common areas so that they provide an outlook while maintaining privacy within the dwelling.

While privacy is important, locating entrances and windows adjacent to public or shared space means that residents can contribute to making the space active and safe. (See figure 6)

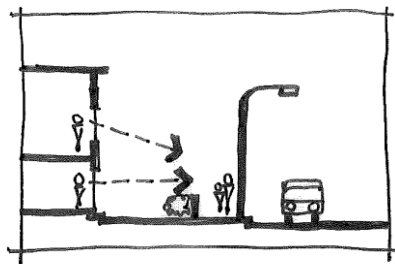

Figure 6: Window placement can enhance passive surveillance of public spaces.

- For dwellings that have a ground-floor level, position the main living areas on the ground floor. This will help maintain privacy to the outdoor areas of adjoining sites.
- Wherever possible, each unit should have its own entry that provides a sheltered threshold. It should be well lit and highly visible as the entrance to the unit. The entry should be able to provide for personalisation by the occupant, and should not be dominated by service areas.

Particularly, rubbish or wheelie bin storage should not be located adjacent to the front door due to potential smell, leakage or pest nuisance.

- Position windows or otherwise restrict or direct outlook so that the short-range view from the main indoor living area of one dwelling is not directly into the main indoor living area of any adjacent dwelling, either within the site or on adjacent sites.

Internal living rooms within dwellings are the most frequently used spaces and should have the highest consideration of privacy afforded to them (See figure 7).

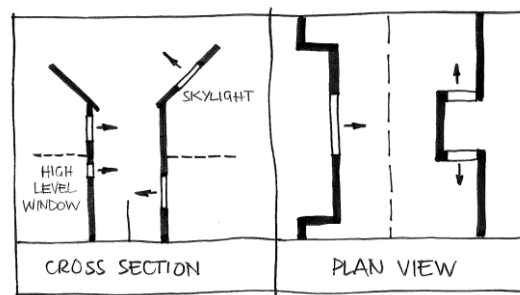

Figure 7: Window positioning can help maintain privacy

- The design and siting of buildings should take into account the potential for development on adjacent sites. The design of a development should therefore aim to maintain privacy and amenity on the site and at the boundaries taking into consideration possible future comprehensive residential development on adjacent sites.

It is important to consider what is permitted or could be developed on adjacent sites. They too could be redeveloped and the same issues of sunlight and privacy will be relevant.

- Housing should be clearly numbered both from the public street and within the site, to assist legibility for both visitors and emergency services.
- Front fences and walls should be designed of materials compatible with the overall development and should ideally incorporate opportunities for visual connection with the adjacent street.

Fences can enhance both the attractiveness of developments, and the ability to provide passive surveillance. The design of fences adjacent to the public street is particularly important (See figure 8).

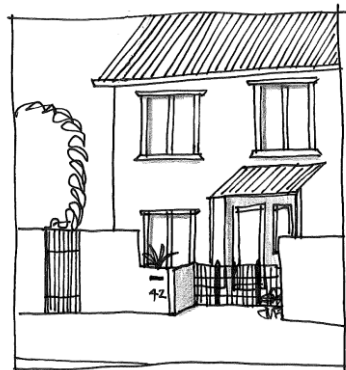

Figure 8: The front entry of a dwelling should be clearly visible.

- Provide lighting as required for night-time way finding and in situations where personal safety is likely to be important.

Lighting for night-time visibility should be energy-efficient, low-glare lighting along paths and accessways within the development and around shared areas. The design and placement of lighting should be included at the stage of developing a landscape plan.

- Mail boxes should be located in accordance with the requirements of NZ Post. Where houses do not have frontage to a public road, the mail boxes should be grouped in a visible location (See figure 9).

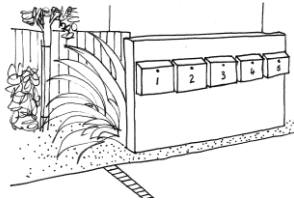

Figure 9: Grouped letter boxes at the front of a site can help strengthen the visibility of an entrance.

Sustainable Development

The inclusion of Overlay Areas in the District Plan aims to ensure that new higher-density housing will be located in the most efficient locations, close to local amenities and public transport. New housing design can also contribute to local infrastructure efficiency by being designed in a way that reduces service infrastructure requirements.

The topography and existing development pattern of much of Upper Hutt provides good opportunities for designing housing that is site-responsive and takes advantage of solar gain, energy efficiency measures and promoting alternative forms of transport such as walking and cycling.

Guidelines

- The orientation and construction methodology of new houses should maximise opportunities for passive solar gain in winter and adequate shade in summer, particularly to the main living areas and private outdoor spaces.

The main indoor living area of a dwelling should ideally receive midwinter sun for at least four hours per day, ideally falling on an interior surface that incorporates thermal mass.

- Opportunities for on-site disposal/soakage of stormwater should be included in the landscaping design.

Developments of multiple units often increase the amount of hard surfacing over a site area by a significant amount. On-site soakage of stormwater reduces the impact of multiple sites on stormwater infrastructure. On-site soakage can be provided by garden areas and lawns, or by using materials such as water-permeable paving or loose chip.

- Noise-sensitive areas of dwellings (such as bedrooms) should be located away from noise generating activities on adjacent sites (i.e. major roads, railway lines or non-residential uses).
- Attached dwellings should employ appropriate noise-resistant wall, ceiling and floor materials and construction details.
- The principles of Crime Prevention through Environmental Design should be applied to all developments.

Refer to Upper Hutt City Design Guidelines for Crime Prevention through Environmental Design, July 2009).



SMALL SITE DESIGN AND DEVELOPMENT

Within the Residential (Centres Overlay) Areas, the District Plan provides for a lower minimum net site area than in other residential areas. As part of the resource consent process for the subdivision of sites in these areas, or for the development of more than one dwelling on a site in these areas, some basic design considerations should be made and assessed against the criteria of this design guide.

Smaller sites require greater care and attention in the design of developments to ensure appropriate standards of on-site, streetscape and townscape amenity are maintained.

These guidelines can also be considered in other areas as a means to ensure fundamental 'good practice' aspects of site design are addressed.

Guidelines

Lot shape and size

- Lots should be designed to be predominantly square or rectangular in shape, and following this, avoiding the creation of areas and shapes that do not contribute to the usability of the lot.
- Lots should be designed to consider the location of outdoor living spaces and to ensure that these will be easily accessible from future buildings.

Site context

- The design and siting of buildings should take into account the existing and future potential for development on adjacent sites. The design of a development should therefore aim to maintain privacy, sunlight access and amenity on the site and at the boundaries taking into consideration existing and possible future residential development on adjacent sites.

It is important to consider what is permitted or could be developed on adjacent sites. They too could be redeveloped and the same issues of sunlight and privacy will be relevant.

On-site amenity

- Small site design and development should meet the matters contained in the guidelines for Comprehensive Residential Developments in respect of:
 - Outdoor living areas (qualitative attributes only);
 - Landscaping, including retention of existing trees, fences, walls, and planting;
 - Servicing and storage facilities;
 - Accommodating vehicles on site;
 - Privacy and safety;
 - Sustainable development.

Many of the quality issues relating to residential development are common to proposals irrespective of whether they are Comprehensive Residential Development or small site development. The same guidelines can be applied for both the sake of consistency, and to ensure that an equally high standard of development and amenity is achieved by small

Comment [81]: What has happened to this following page?? Looks like it was like this in the notified chapter...

**Character Assessment:
CENTRAL AREA**



Amended August 2013 (Plan Change 18)
The Central Residential (Centres Overlay) Area surrounds the CBD of Upper Hutt and represents a key

Connection
The Central Area surrounds the CBD of Upper Hutt City and is therefore close to the numerous



**Character Assessment:
TRENTHAM**



Trentham is a suburb located 3km southwest of the CBD. The area comprising the Residential (Centres Overlay) Area is located directly north of the railway station between Stafford Street and Fergusson Drive, from Ranfurly Street in the east to Bathurst Street in the west.

The general character of Trentham is a pleasant suburb with good local amenities such as Trentham Memorial Park, Trentham Racecourse and convenient access to public transport services.

Further to these amenities, Trentham has a number of existing character elements that any new development should seek to maintain and enhance through good design and planning:

- Connection
- Dwelling Style / Materials
- Layout
- Dwelling Type
- Boundaries

Connection

The train connects Trentham to Upper Hutt CBD in 5 minutes and southern connections to Lower Hutt and Wellington are regular, with travel times of around 30mins and 40mins respectively.

To the south of the train line is the Trentham Racecourse, and to the north of Fergusson Drive is Trentham Memorial Park which provides both local landscape amenity, sports grounds and local recreation activities.

The streets around Trentham are tree-lined, wide and open, which allows for good views to the north and south and visual links to the park and the racecourse. Opportunities exist to improve these links and the quality of public space with high quality developments and good street design.

Style Materials

There are a number of well-maintained cottage-style properties in the area that could inform a general style for any future development in Trentham. This style incorporates timber construction clad in weatherboards, with pitched roofs, bargeboards and carved detailing.



Example of timber cottage detailing

Site boundaries

A large number of existing properties along Ararino Street have a high fence adjacent to the street boundary. This is a feature that should be discouraged in future as it creates an inactive edge to the public space and reduces the opportunity for passive surveillance of the street.



Dwelling Type

Variety in the type of housing in Trentham is not great and any new development should seek to provide a range of housing types to encourage a wider diversity of people to live in Trentham.

Layout

The main Trentham shops are located on Camp Street but there are additional shops and businesses on Ararino Street and along Fergusson Drive, interspersed with housing. Any future development of the area should seek to encourage and support one of these areas to develop into a more coherent centre. A key opportunity would be to provide a greater density of housing within the walking catchment of shops.



Local shops on the corner of Islington St. and Fergusson Dr. (left) and on Camp St. (right)

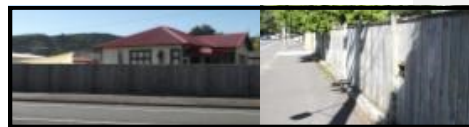

Inactive edges along Ararino St.

Character Assessment: WALLACEVILLE



The Wallaceville Residential (Centres Overlay) Area is located to the south of the Upper Hutt CBD on the south side of the train line. The area is comprised of a mix of residential and industrial uses.

Assessment of Wallaceville has identified a number of local characteristics that should influence future development.

The assessment identified the following elements as having particular qualities that are important to the character of Wallaceville:

- Setting
- Connections
- Housing

Any future development of sites in this area should seek to retain the following qualities through good design and planning.

Setting

Physical features play an important part in the character of Wallaceville. Views of the hillsides are prominent to the north and, even more so, the south. Seddon Street and Wilford Street are long, straight roads that run east-west with clear sight lines and minimal signage.

Views of the hills to the south of Wallaceville are visible between the houses on Seddon Street and through and over the dwellings on Wilford Street. This is an important part of the character and amenity of the area and any future development should seek to maximise this aspect from both public and private locations.



View of Southern Hills from Wilford St



Seddon Street and Ward Street, lined with trees

Connections

The area is well served by public transport links and is within walking distance of the Upper Hutt CBD. The road layout is simple and legible, with street trees and a wide carriageway and footpaths. Development should seek to improve connections and encourage sustainable methods of travel within the area such as walking and cycling.



Style and Materials

There is no particular architectural style that can be attributed to the Wallaceville area. The housing stock is varied in scale, style, type, material and detailing. The variation of styles and materials allows for individuality within the street scene which should be retained.

The proximity to the industrial zone and the former AgResearch site give an opportunity for a more contemporary design style to be introduced in this area.

Dwelling Type

Current housing stock includes many small to medium sized one-storey dwellings, some of which have been converted into flats. Smaller dwellings are therefore common in the area and this housing type can be encouraged in new forms in the future.

Setbacks

The large majority of properties have generous building setbacks from the front boundary, which has given rise to a prevalence of activity occurring in front yards. This gives the streets in this area a unique sense of vitality and should be encouraged in any future development. Front boundaries are generally marked with low level wooden fences, which allow for surveillance and further contribute to a general feeling of openness and space.



Front yard uses in Wallaceville

Appendix Residential 3

Maidstone Terrace Residential

